

# XL marlin Lighting

## Garden spike Lighting (OLSSL45W) installation Instruction

The user: Thank you for your purchase of this product, read this instruction manual before usage

1. Model: OLSSL45W
2. Rated Voltage: 110-240V/50-60Hz
3. Rated Power: LED 45W
4. IP Grade: IP65
5. Operating Temperature: -15~40°C

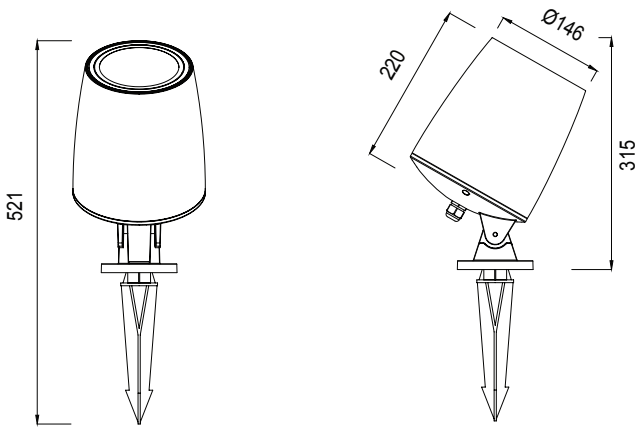

- Always disconnect the power supply before installing or performing any maintenance operations.
- Installation should be carried out by a suitably qualified person in accordance with good electrical practice and the appropriate national wiring regulations.
- These luminaires are widely used in commercial lighting, home decoration lighting, art gallery and museums.
- Only can be touched after 3 minutes later when power off, so as to avoid burns.
- Dismantling and refit are forbidden
- Installation on inflammables is forbidden.

If the external flexible cable or cord of this luminaire is damaged, it shall be exclusively replaced by the manufacturer or his service agent or a similar qualified person in order to avoid a hazard.

1. Prepare the ground  
If the ground is hard or installation is difficult, thoroughly, wet the ground where you wish to install the spike using a garden hose or watering can.

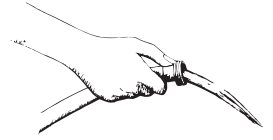

2. Assemble the light bracket section on the ground stake

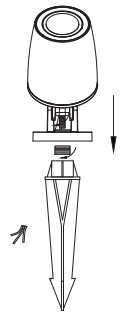

3. Connect the cable .  
Live line for L terminal,  
Null line for N terminal,  
Ground line for E terminal.

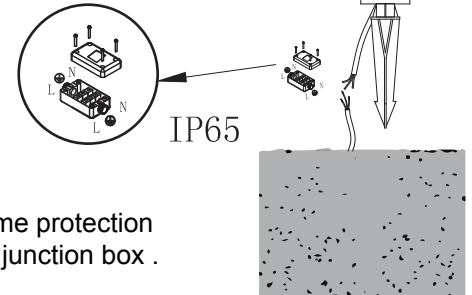

4. Insert the ground stake into the soil.

5. Adjust the tilt of the light for a suitable direction for your application, and fix the joint screw

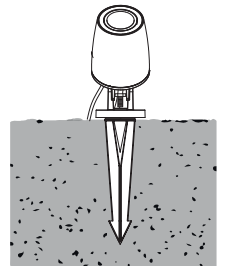

6. Connect the power supply, light up the lamp.