

# XL marlin Lighting

Prolux IP44 Downlight ( PR4F10IP44WHX ) Installation Instruction

The user: thank you for your purchase use this product, read this instruction manual before usage

1. Model: PR4F10IP44WHX
2. Rated Voltage: 230/240V 50 Hz
3. Rated Power: 12W
4. IP Grade: IP44
5. Operating Temperature: C -10 To +45

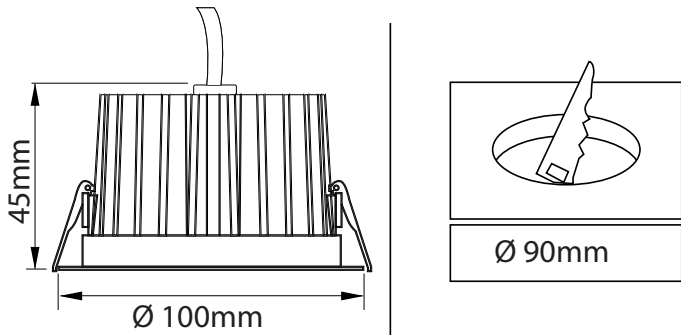

- Always disconnect the power supply before installing or performing any maintenance operations.
- Installation should be carried out by a suitably qualified person in accordance with good electrical practice and the appropriate national wiring regulations.
- These luminaires are widely used in commercial lighting, home decoration lighting, art gallery and museums.
- Only can be touched after 3 minutes later when power off, so as to avoid burns.
- Dismantling and refit are forbidden
- Installation on inflammables is forbidden.

If the external flexible cable or cord of this luminaire is damaged, it shall be exclusively replaced by the manufacturer or his service agent or a similar qualified person in order to avoid a hazard.

## 1. PREPARE THE CEILING

Open a hole according to the dimension of the downlight.

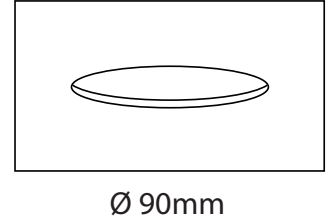

## 2. CONNECT THE CABLE .

Live line for L terminal,  
Null line for N terminal,  
Ground line for E terminal.

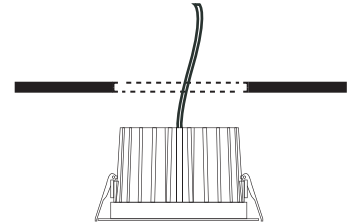

## 3. PUSH THE FIXTURE into the opening

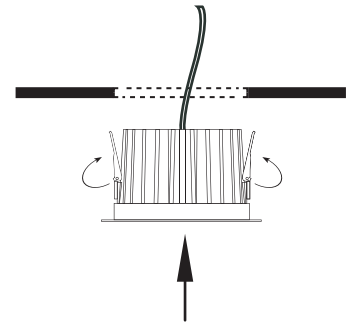

## 4. CONNECT THE POWER SUPPLY, light up the lamp.

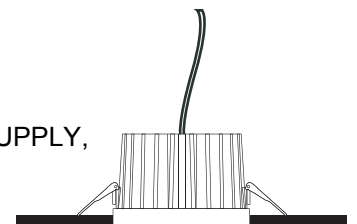

The light source of this luminaire is not replaceable; when the source reaches its end of life the whole luminaire shall be replaced

Welcome you again to buy our products