

Model: FOL32SL3 FOL Focus



General Data

Power	32 W
LED type	COB
Luminous flux	2800 lm
CCT	3000K or 4000K as standard. Different CCT upon request.
CRI	80+
Beam angle	12°/24°/36°/60°
Color	White/Grey/black
Lamp Life	50000 hrs
SDCM	≤5
Oper. Temp.	C -25° +40°
Certifications	CE, RoHS
Dimming	1-10V/DALI

Construction Data

IP rating	20 Indoor
Housing	Solid aluminum housing CNC machined body
Protection finishing	passivated (anodizing) anti-corrosion finishing
Glass	Tempered glass diffuser

Electrical Data

Input voltage	AC 120-240 V
Cable	/

Dimension Drawing

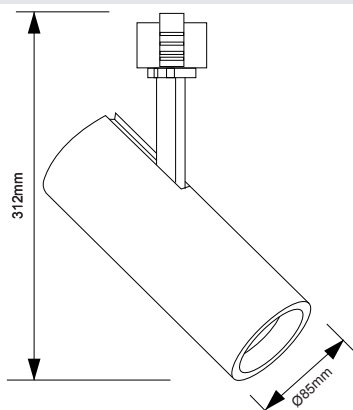

APPLICATIONS

Ideal for application where comfort and nice atmosphere is required, like restaurants, cafes, hotels lobbies, retail lighting and high-end commercial areas

PRODUCT DESCRIPTION

32W Three Circuit FOL Type. Optimal thermal dissipation. Adjustable up to 350° and up to 90° vertically. With CCT, 3000K or 4000K, different CCT upon request. Beam angles, 12°/24°/36°/60°.

FIXTURE CONSTRUCTION

Made of die cast aluminum body and heat sink and aluminum reflector. The adaptor locks the spotlight positively to the track, LED light source, PC gear box and electronic non dimmable driver. comes in white, black and silver

White Lamp Options

Part Number	CCT	Beam angle
FOL32SL3WH312	3000 K	12°
FOL32SL3WH412	4000 K	12°
FOL32SL3WH324	3000 K	24°
FOL32SL3WH424	4000 K	24°
FOL32SL3WH336	3000 K	36°
FOL32SL3WH436	4000 K	36°
FOL32SL3WH360	3000 K	60°
FOL32SL3WH460	4000 K	60°

Black Lamp Options

Part Number	CCT	Beam angle
FOL32SL3BL312	3000 K	12°
FOL32SL3BL412	4000 K	12°
FOL32SL3BL324	3000 K	24°
FOL32SL3BL424	4000 K	24°
FOL32SL3BL336	3000 K	36°
FOL32SL3BL436	4000 K	36°
FOL32SL3BL360	3000 K	60°
FOL32SL3BL460	4000 K	60°

Grey Lamp Options

Part Number	CCT	Beam angle
FOL32SL3GR312	3000 K	12°
FOL32SL3GR412	4000 K	12°
FOL32SL3GR324	3000 K	24°
FOL32SL3GR424	4000 K	24°
FOL32SL3GR336	3000 K	36°
FOL32SL3GR436	4000 K	36°
FOL32SL3GR360	3000 K	60°
FOL32SL3GR460	4000 K	60°

Photometric Data

Light Distribution Curve [Unit: cd]

