

Model: FO15SL3 FO Focus



General Data

Power	15 W
LED type	LED Luminous
Luminous flux	800 lm / 820 lm
CCT	3000K or 4000K as standard. Different CCT upon request.
CRI	80+
Beam angle	24°/40°/60°
Color	White/Sliver/black
Lamp Life	50000 hrs
SDCM	≤5
Oper. Temp.	C -25° +40°
Certifications	CE, RoHS
Dimming	1-10V/DALI

Construction Data

IP rating	20 Indoor
Housing	Solid aluminum housing CNC machined body
Protection finishing	passivated (anodizing) anti-corrosion finishing
Glass	Tempered glass diffuser

Electrical Data

Input voltage	AC 120-240 V
Cable	/

Dimension Drawing

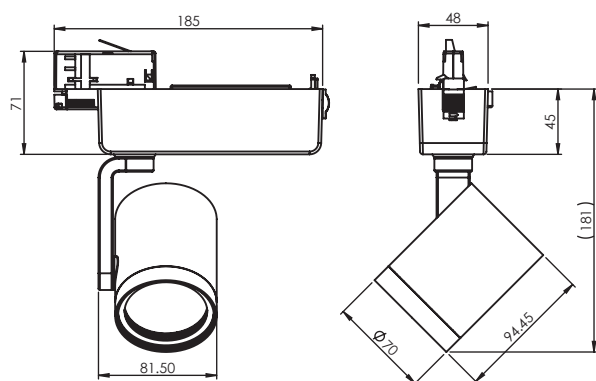

APPLICATIONS

Excellent solution to highlight objects, statues, paints, and gives flexibility to the designer to decide where and what effect to achieve in selected angle.

PRODUCT DESCRIPTION

10W Three Circuit FO Type. Optimal thermal dissipation. Adjustable up to 350° and up to 90° vertically. With CCT, 3000K or 4000K different CCT upon request. Beam angles, 24°/40° or 60°

FIXTURE CONSTRUCTION

Made of die cast aluminum body and heat sink and aluminum reflector. The adaptor locks the spotlight positively to the track, LED light source, PC gear box and electronic non dimmable driver. comes in white, black and silver

White Lamp Options

Part Number	CCT	Beam angle
FO15SL3WH324	3000 K	24°
FO15SL3WH424	4000 K	24°
FO15SL3WH340	3000 K	40°
FO15SL3WH440	4000 K	40°
FO15SL3WH360	3000 K	60°
FO15SL3WH460	4000 K	60°

Black Lamp Options

Part Number	CCT	Beam angle
FO15SL3BL324	3000 K	24°
FO15SL3BL424	4000 K	24°
FO15SL3BL340	3000 K	40°
FO15SL3BL440	4000 K	40°
FO15SL3BL360	3000 K	60°
FO15SL3BL460	4000 K	60°

Silver Lamp Options

Part Number	CCT	Beam angle
FO15SL3SL324	3000 K	24°
FO15SL3SL424	4000 K	24°
FO15SL3SL340	3000 K	40°
FO15SL3SL440	4000 K	40°
FO15SL3SL360	3000 K	60°
FO15SL3SL460	4000 K	60°

Photometric Data

Light Distribution Curve [Unit: cd]

