

Model: XLQD40



General Data

Lamp Type	3030 2D
System Watts	40 W
Lumens	5600 lm
Lamp Life	50000 hrs
CRI	>80 Ra
IP Rating	IP 65
Weight (Kgs)	3.2 Kgs
Voltage	110-240V
Dimming	1-10 W / DALI
CCT	3000/5700K
Oper. temp.	-40 to +50

Construction Data

IP rating	65 waterproof
Housing	Die-cast Aluminum
Protection finishing	AkzoNobel Powder-coated black colour finish
Glass	Tempered glass diffuser
Loading capacity	/
Cable Gland	IP65
Gasket	Silicone rubber gasket

Electrical Data

Input voltage	AC100-240V
Cable	Cable gland for waterproof IP65

Accessories

Bracket	Angle Bracket
Clip	/

APPLICATIONS

Suitable for Warehouses, Workshops, Gymnasiums, Gas Stations, Toll Stations, Supermarkets, Exhibition halls and many other Industrial and commercial lighting applications.

PRODUCT DESCRIPTION

LED Modular flood light, 5 years warranty, Osram/ Lumileds LED, Meanwell Driver, Diecast Aluminum body with Stainless steel screws. Available in multiple dimming options such as Dali, 1-10V Dimming.

FIXTURE CONSTRUCTION

Die cast Aluminum body, powerful thermal dissipation and IP65 waterproof performance. Available in other colours, die cast aluminum heat sink.

Dimension Drawing

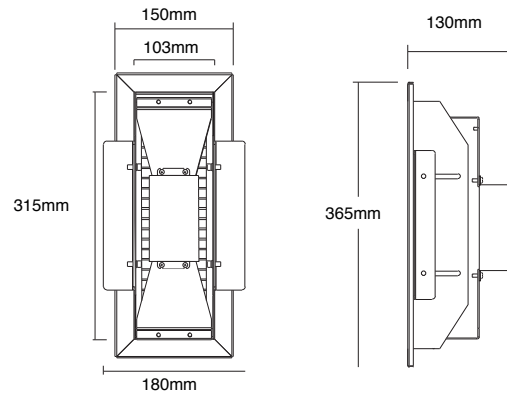

Lamp Options

Part Number	CCT	Beam angle
XLQD40360	3000 K	60°
XLQD40460	7500 K	60°
XLQD40390	3000 K	90°
XLQD40490	7500 K	90°
XLQD403110	3000 K	110°
XLQD404110	7500 K	110°

Photometric Data

Light Distribution Curve

