

**Model: FO15SL1 FO Focus**



**General Data**

Power	15 W
LED type	LED Luminous
Luminous flux	800 lm / 820 lm
CCT	3000K or 4000K as standard. Different CCT upon request.
CRI	80+
Beam angle	24°/40°/60°
Color	White/Sliver/black
Lamp Life	50000 hrs
SDCM	≤5
Oper. Temp.	C -25° +40°
Certifications	CE, RoHS
Dimming	1-10V/DALI

**Construction Data**

IP rating	20 Indoor
Housing	Solid aluminum housing CNC machined body
Protection finishing	passivated (anodizing) anti-corrosion finishing
Glass	Tempered glass diffuser

**Electrical Data**

Input voltage	AC 120-240 V
Cable	/

**Dimension Drawing**

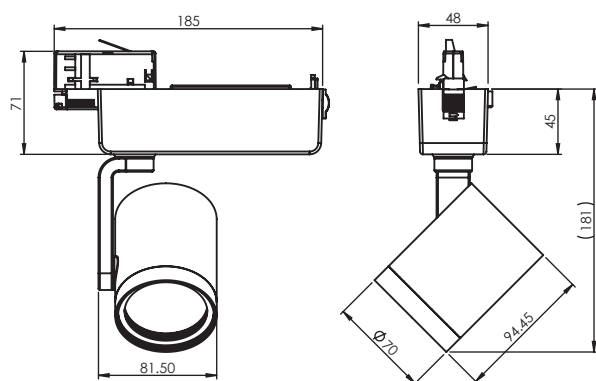

**APPLICATIONS**

Excellent solution to highlight objects, statues, paints, and gives flexibility to the designer to decide where and what effect to achieve in selected angle.

**PRODUCT DESCRIPTION**

15W Single Circuit FO Type. Optimal thermal dissipation. Adjustable up to 350° and up to 90° vertically. With CCT, 3000K or 4000K different CCT upon request. Beam angles, 24°/40° or 60°

**FIXTURE CONSTRUCTION**

Made of die cast aluminum body and heat sink and aluminum reflector. The adaptor locks the spotlight positively to the track, LED light source, PC gear box and electronic non dimmable driver. comes in white, black and silver

**White Lamp Options**

Part Number	CCT	Beam angle
FO15SL1WH324	3000 K	24°
FO15SL1WH424	4000 K	24°
FO15SL1WH340	3000 K	40°
FO15SL1WH440	4000 K	40°
FO15SL1WH360	3000 K	60°
FO15SL1WH460	4000 K	60°

**Black Lamp Options**

Part Number	CCT	Beam angle
FO15SL1BL324	3000 K	24°
FO15SL1BL424	4000 K	24°
FO15SL1BL340	3000 K	40°
FO15SL1BL440	4000 K	40°
FO15SL1BL360	3000 K	60°
FO15SL1BL460	4000 K	60°

**Silver Lamp Options**

Part Number	CCT	Beam angle
FO15SL1SL324	3000 K	24°
FO15SL1SL424	4000 K	24°
FO15SL1SL340	3000 K	40°
FO15SL1SL440	4000 K	40°
FO15SL1SL360	3000 K	60°
FO15SL1SL460	4000 K	60°

**Photometric Data**

Light Distribution Curve [Unit: cd]

