

XL marlin Lighting

Hilux-Canopy Light (XLQD200) Installation Instruction

The user: thank you for your purchase use this product, read this instruction manual before usage

1. Model: XLQD200
2. Rated Voltage: AC110-240V
3. Rated Power : 200 W
4. IP Grade: IP65
5. Insulation protection level: Class I
6. Operating Temperature: --40~50°C

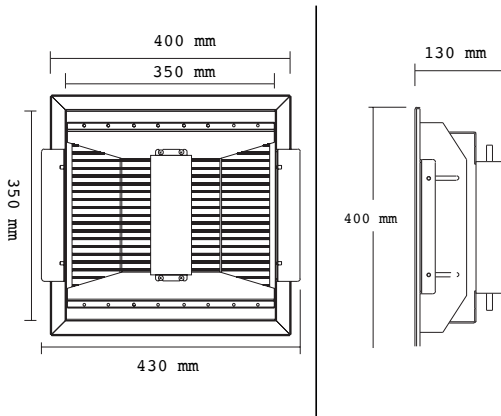

- Always disconnect the power supply before installing or performing any maintenance operations.
- Installation should be carried out by a suitably qualified person in accordance with good electrical practice and the appropriate national wiring regulations.
- These luminaires are widely used in commercial lighting, home decoration lighting, art gallery and museums.
- Only can be touched after 3 minutes later when power off, so as to avoid burns.
- Dismantling and refit are forbidden
- Installation on inflammables is forbidden.

If the external flexible cable or cord of this luminaire is damaged, it shall be exclusively replaced by the manufacturer or his service agent or a similar qualified person in order to avoid a hazard.

1. Open the mounting hole on the Ceiling Panel

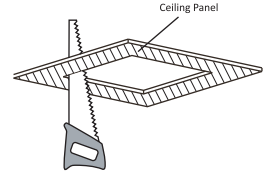

2. Fix the frame (follow drawing steps)

Remove two(2) Ceiling Securing Fittngs of one side, bring the side of Luminaire Frame with Ceiling Securing Fittngs into Ceiling Panel.

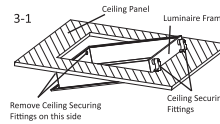

Bring entire Luminaire Frame into Ceiling Panel, Clamp the Ceiling Panel by Ceiling Securing Fittngs and tighten by 6mm (5/32") Allen Wrench.

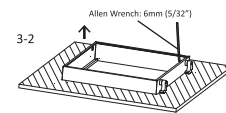

Mount the removed Ceiling Securing Fittngs back to Luminaire Frame, notice that the both sides are opposited. Clamp and tighten by 6mm (5/32") Allen Wrench.

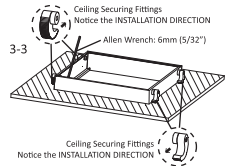

3. Connect the Power Cord to the supply wiring per "Electrical Connections" section for completing electrical connections.

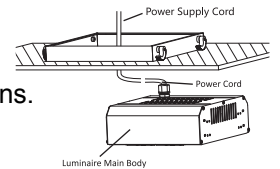

4. Tilt and bring the Luminaire Main Body into Luminaire Frame after the step of "Electrical Connections".

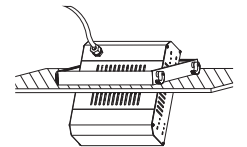

5. Place the Luminaire Main Body by horizontal onto Luminaire Frame, fine tuning and ensure the Luminaire Main Body is snapped into to the slot of Luminaire Frame.

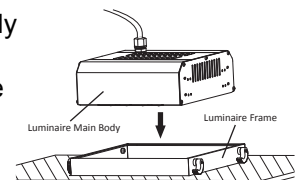

6. Connect the power supply, light up the lamp.