

XL marlin Lighting

Exterior Wall Recessed Lighting (OLM003508B) Installation Instruction

The user: thank you for your purchase use this product, read this instruction manual before usage

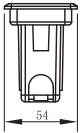
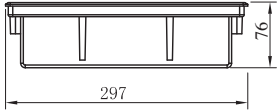

1. Model: OLM003508B
2. Rated Voltage: AC100-255V
3. Rated Power : 5W
4. IP Grade: IP65
5. Insulation protection level: Class I
6. Operating Temperature: -30°-45°



Housing Form

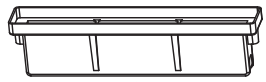

Recessed Box

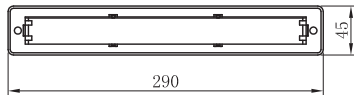
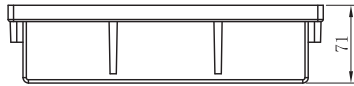

- Always disconnect the power supply before installing or performing any maintenance operations.
- Installation should be carried out by a suitably qualified person in accordance with good electrical practice and the appropriate national wiring regulations.
- These luminaires are widely used in commercial lighting, home decoration lighting, art gallery and museums.
- Only can be touched after 3 minutes later when power off, so as to avoid burns.
- Dismantling and refit are forbidden
- Installation on inflammables is forbidden.

If the external flexible cable or cord of this luminaire is damaged, it shall be exclusively replaced by the manufacturer or his service agent or a similar qualified person in order to avoid a hazard.

1. PREPARE THE WALL

Dug a hole according to the dimension of the mounting sleeve.

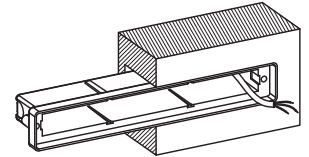

2. PLACE THE RECESSED BOX

3. CONNECT THE CABLE .

Live line for L terminal, Null line for N terminal, Ground line for E terminal.

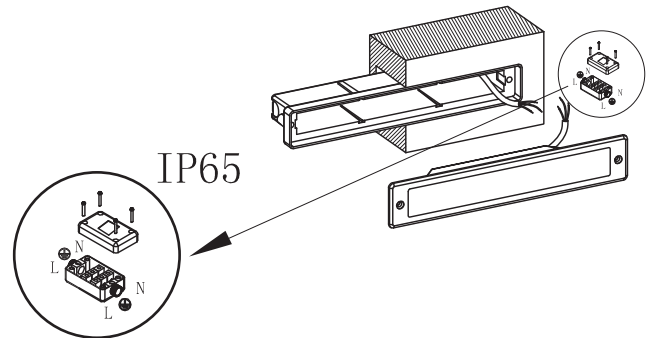

4. PUSH THE FIXTURE INTO THE RECESSED BOX.

Make sure the screws be fixed tightly.

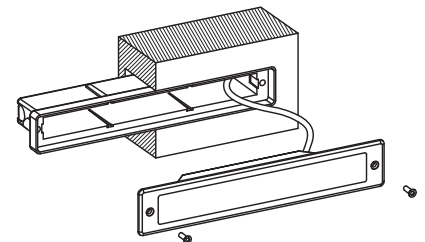

5. CONNECT THE POWER SUPPLY, light up the lamp.

The light source of this luminaire is not replaceable; when the source reaches its end of life the whole luminaire shall be replaced

Welcome you again to buy our products