

XL marlin Lighting

MY Type Modular Trim (SYR202WH) Installation Instruction

The user: thank you for your purchase use this product, read this instruction manual before usage

1. Model: SYR202WH

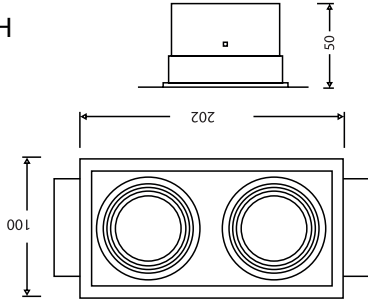

Trim →

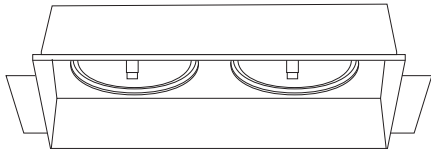

Trim Ring →

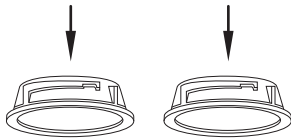

- Always disconnect the power supply before installing or performing any maintenance operations.
- Installation should be carried out by a suitably qualified person in accordance with good electrical practice and the appropriate national wiring regulations.
- These luminaires are widely used in commercial lighting, home decoration lighting, art gallery and museums.
- Only can be touched after 3 minutes later when power off, so as to avoid burns.
- Dismantling and refit are forbidden
- Installation on inflammables is forbidden.

If the external flexible cable or cord of this luminaire is damaged, it shall be exclusively replaced by the manufacturer or his service agent or a similar qualified person in order to avoid a hazard.

1. Prepare The Ceiling
Open a hole according to the dimension of the downlight

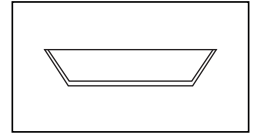

202x100 mm

2. Insert built-in fitting into the ceiling and fix it with screws

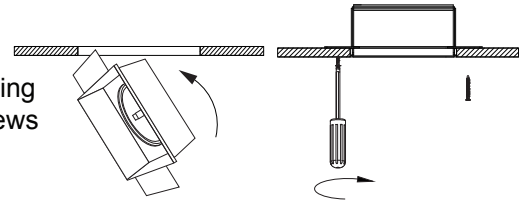

3. Plaster ceiling surround downlight Buid-in fitting before mounting downlight into housing

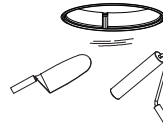

4. Rotate Counterclockwise To release The Ring

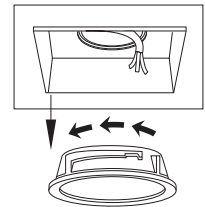

5. Push The Ring To The Lamp

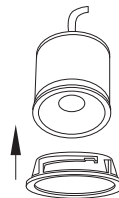

6. Connect The Cable Of The Driver .

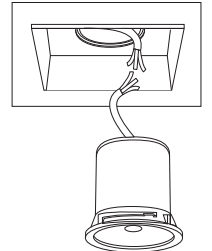

7. Push The Fixture, Rotate Clockwise To Fix The Ring To Trim

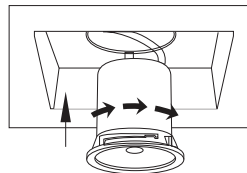

8. Connect The Power Supply, Light Up The Lamp.

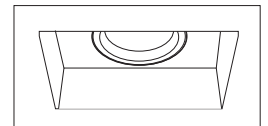

FOR SUITABLE TRIMS FOR THE MO/MX TYPE MODULAR SEE :
XL MARLIN LIGHTING CATALOGUE