

Model: XL65PNOL40E



General Data

LED Type	SMD2835
Watts	40 W
Lumens	4000lm
Lamp Life	50000 hrs
CRI	>80 Ra
Beam Angle	120°
IP Rating	IP65
Weight	3.4 Kgs
Voltage	220-240V
Dimming	1-10 V / DALI
CCT	3000K/4000K/6000K
Opr. Temp.	-20 to +40
Dime. mm	1195x295x30mm

Dimension Drawing

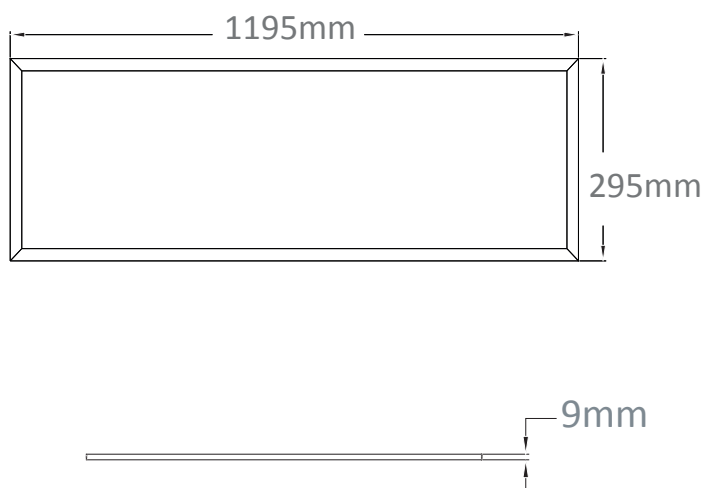

APPLICATIONS

Ideal for indoor general lighting for commercial and residential applications such as schools, meeting rooms, offices, hospitals, supermarket, hypermarkets, warehouses.

PRODUCT DESCRIPTION

Slim design recessed or surface mounted high output LED panels with white aluminum frame and remote driver, the panel comes with opal diffuser, IP65.

FIXTURE CONSTRUCTION

Aluminum body with opal diffuser, with remote non dimmable, dimmable, or Dali driver, excellent rendering above CRI>80, IP65.

Lamp Options

Part Number	CCT
XL65PNOL40EC3	3000 K
XL65PNOL40EC4	4000 K
XL65PNOL40EC6	6000 K

Photometric Data

Lamp=4 031.1 lm (100%)
Max=1 910 cd
Multiplier=1 cd
Power=41 W
Degree=0

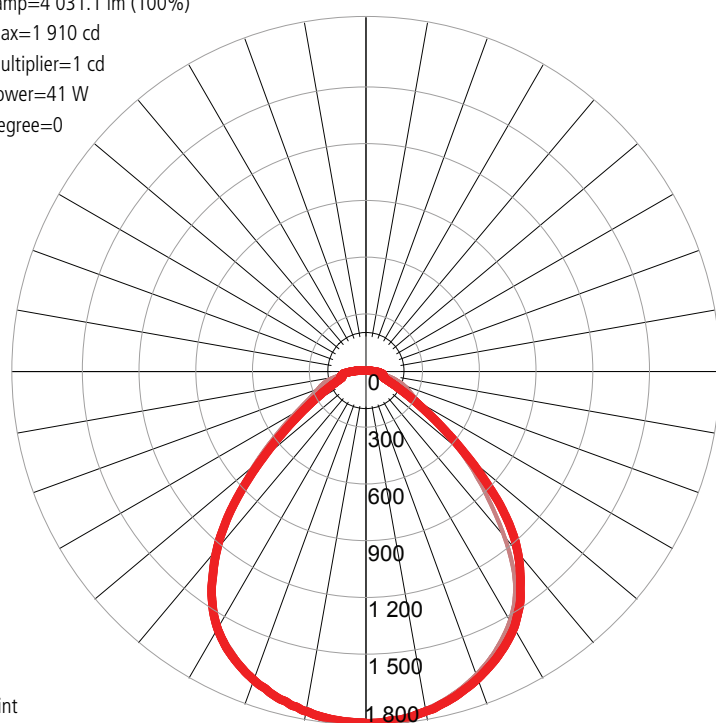

Point
Manufacturer: 0
Luminaire catalog: 595x595-6000K
Luminaire: 1