

Model: OL1000L2330



General Data

Power	11 W
LED type	2835 SMD
Luminous flux	220 lm
CCT	3000K,4000K and RGB as standard. Different CCT upon request.
CRI	80+
Beam angle	120°
Dimension	1000x35x62mm
Cut out dia.	/
Weight (kgs)	1.1 kgs
Lamp Life	50000 hrs
SDCM	≤5
Ambient Temp.	/
RAL Color	80+
Oper. Temp.	/
Certifications	CE, RoHS

Construction Data

IP rating	65 waterproof
Housing	Cast aluminum body
Protection finishing	passivated (anodizing) anticorrosion finishing
Glass	Tempered glass
Loading capacity	/
Cable Gland	IP65
Gasket	Silicone rubber gasket
connector	waterproof connector male+female.

Electrical Data

Input voltage	AC110~240V
Cable	Cable gland for waterproof IP65

APPLICATIONS

These lights are used in exterior applications, such as Facade lighting, columns, walls, architectural features, landscape features for hotels, as well as residential applications, etc.

PRODUCT DESCRIPTION

Wall Surface-mounted slim Linear luminaire for outdoor installation, length 300mm, anodized extruded aluminum body, PMMA diffuser, stainless steel screws, Remote driver needed, Low power 2835 SMD LED, IP65 rated

FIXTURE CONSTRUCTION

Cast aluminum body, with passivated (anodizing) anticorrosion finishing, Stainless steel screws, Silicon seal gaskets and cable gland for waterproof IP65 with waterproof connector male+female.

Accessories

- Mounting Sleeve /
- Clip /

Dimension Drawing

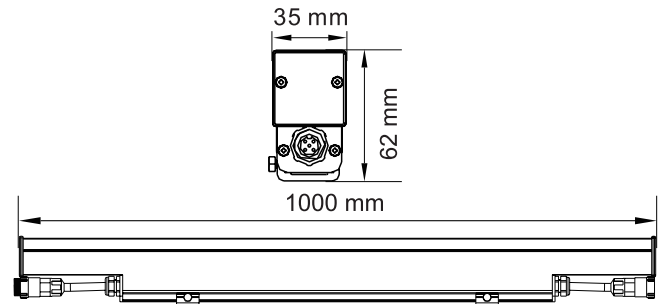

Lamp Options

Part Number	CCT	Beam angle
OL1000L2330C3B120	3000 K	120°
OL1000L2330C4B120	4000 K	120°
OL1000L2330CRGBB120	RGB	120°

Photometric Data

Light Distribution Curve

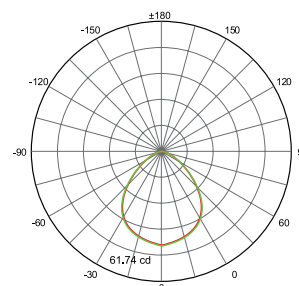

Illumination Drawing

