

XL marlin Lighting

Exterior Wall Mounting Lighting (OLB803482) Installation Instruction

The user: thank you for your purchase use this product, read this instruction manual before usage

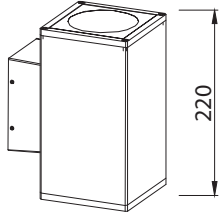

1. Model: OLB803482
2. Rated Voltage: AC110~240V
3. Rated Power : 8X2 W
4. IP Grade: IP65
5. Insulation protection level: Class I
6. Operating Temperature: -30°-45°

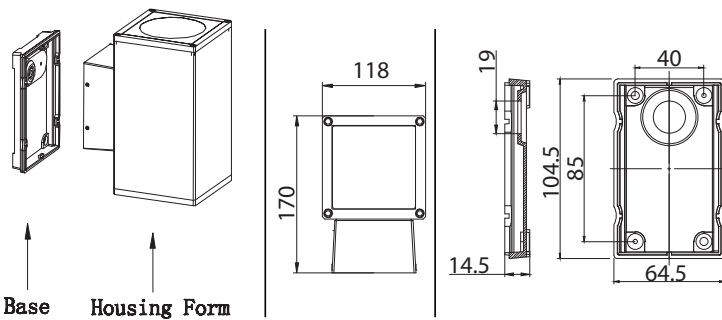

- Always disconnect the power supply before installing or performing any maintenance operations.
- Installation should be carried out by a suitably qualified person in accordance with good electrical practice and the appropriate national wiring regulations.
- These luminaires are widely used in commercial lighting, home decoration lighting, art gallery and museums.
- Only can be touched after 3 minutes later when power off, so as to avoid burns.
- Dismantling and refit are forbidden
- Installation on inflammables is forbidden.

If the external flexible cable or cord of this luminaire is damaged, it shall be exclusively replaced by the manufacturer or his service agent or a similar qualified person in order to avoid a hazard.

1. INSTALL THE LIGHT BACE on the location, make sure the screws be fixed tightly.

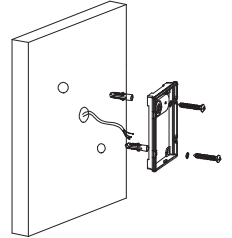

2. CONNECT THE CABLE .
Live line for L terminal,
Null line for N terminal,
Ground line for E terminal.

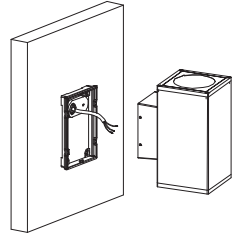

indicate same protection class IP 65 junction box .

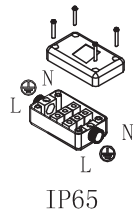

3. PUSH THE FIXTURE INTO THE BACE.
Make sure the screws be fixed tightly.

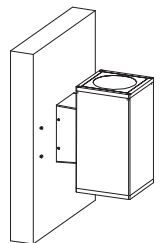

5. CONNECT THE POWER SUPPLY,
light up the lamp.