

XL marlin Lighting

Hilux Highbay Light (XLHBL240W) Installation Instruction

The user: thank you for your purchase use this product, read this instruction manual before usage

- 1.Model: XLHBL240W
- 2.Rated Voltage: 100 - 240V
- 3.Rated Power : 250W
- 4.IP Grade: IP66
- 5.Operating Temperature:-40 to +50

Suspended mounting arrangement

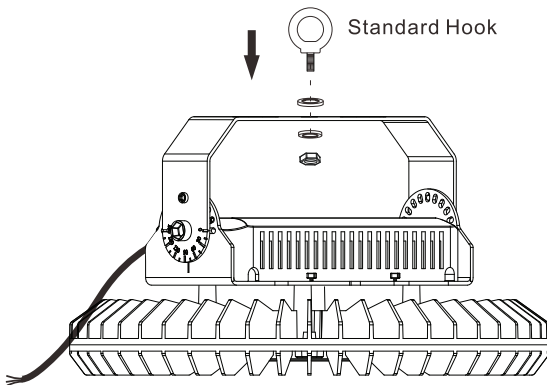

- Always disconnect the power supply before installing or performing any maintenance operations.
- Installation should be carried out by a suitably qualified person in accordance with good electrical practice and the appropriate national wiring regulations.
- These luminaires are widely used in warehouses, factories, workshops, gymnasiums, exhibition halls, and many other Industrial and commercial lighting applications.
- Only can be touched after 3 minutes later when power off, so as to avoid burns.
- Dismantling and refit are forbidden.
- Installation on inflammables is forbidden.

If the external flexible cable or cord of this luminaire is damaged, it shall be exclusively replaced by the manufacturer or his service agent or a similar qualified person in order to avoid a hazard.

Surface mounting arrangement

1. Place the LED Hilux Highbay light at the required locations and aim them according to your lighting design.

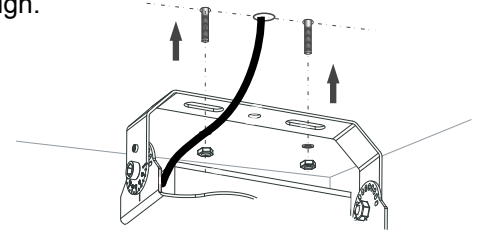

2. Adjust the rotary angle bracket to required angle.

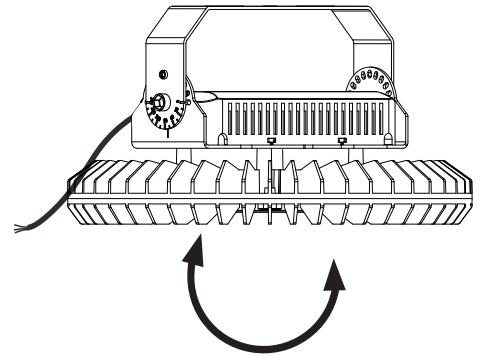

3. Connect the LED Hilux Highbay light into the power outlets and use a waterproof IP65 connector to make sure the fixture is protected.

(A)

indicate same protection class IP 66 junction box.

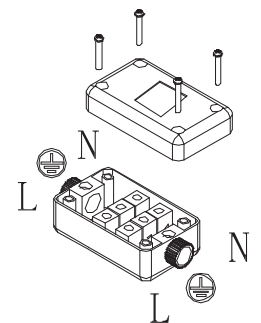

IP66

4. Connect the power supply, light up the lamp.