

XL marlin Lighting

MO/MX Type Modular Trim (FL3XX) Installation Instruction

The user: thank you for your purchase use this product, read this instruction manual before usage

1. Model: FL3XX

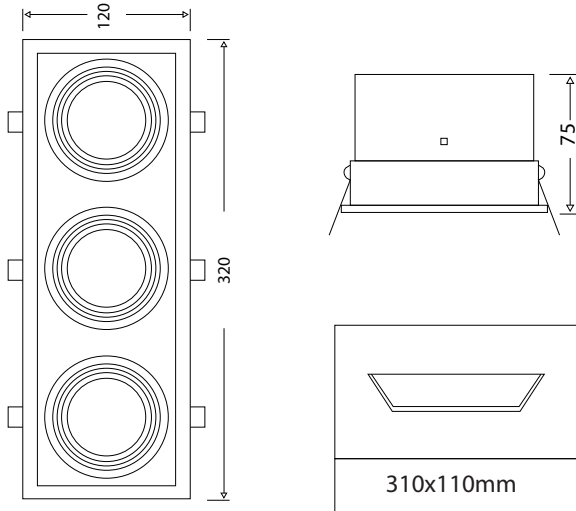

- Always disconnect the power supply before installing or performing any maintenance operations.
- Installation should be carried out by a suitably qualified person in accordance with good electrical practice and the appropriate national wiring regulations.
- These luminaires are widely used in commercial lighting, home decoration lighting, art gallery and museums.
- Only can be touched after 3 minutes later when power off, so as to avoid burns.
- Dismantling and refit are forbidden
- Installation on inflammables is forbidden.

If the external flexible cable or cord of this luminaire is damaged, it shall be exclusively replaced by the manufacturer or his service agent or a similar qualified person in order to avoid a hazard.

1. PREPARE THE CEILING

Open a hole according to the dimension of the downlight trim that you choose to be used with the modular.

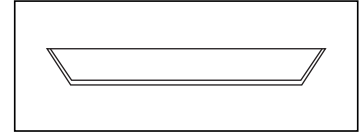

310x110mm

2. CONNECT THE CABLE OF THE DRIVER .

Live line for L terminal,
Null line for N terminal,
Ground line for E terminal.

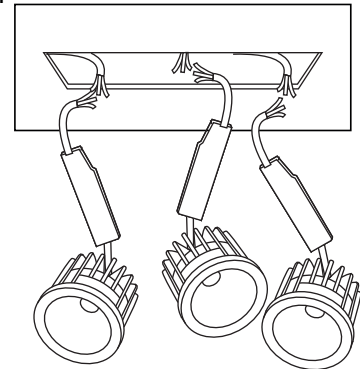

3. CONNECT POWER PLUG OF LED MODULAR to that of the LED driver

4. PRESS THE LED FIXTURE TO THE TRIM

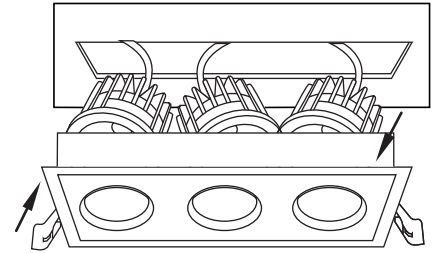

5. PUSH THE FIXTURE into the opening

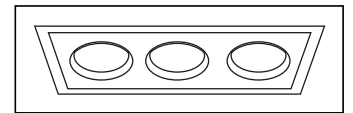

6. CONNECT THE POWER SUPPLY, light up the lamp.

FOR SUITABLE TRIMS FOR THE MO/MX TYPE
MODULAR SEE :
XL MARLIN LIGHTING CATALOGUE