

Model: OLS10280W



Lamp Options

Part Number	CCT	Beam angle
OLS10280WC3	3000 K	/
OLS10280WC4	4000 K	/

General Data

Power	280W
LED type	PHILIPS
Luminous flux	35000 lm
CCT	3000K or 4000K as standard. Different CCT upon request.
CRI	70+
Dimension	455x950x137mm
Cut out dia.	/
Weight (kgs)	/
Lamp Life	50000 hrs
SDCM	≤5
Ambient Temp.	-35~50°C
RAL Color	7024
Certifications	CE, RoHS

Construction Data

IP rating	66 waterproof
Housing	Solid aluminum housing CNC machined body
Protection finishing	passivated (anodizing) anti-corrosion finishing
Glass	Tempered glass diffuser
Loading capacity	/
Cable Gland	IP66
Gasket	Silicone rubber gasket

Electrical Data

Input voltage	AC 100~240V
Cable	/

APPLICATIONS

These lights are widely used in exterior applications, such as Urban or Street lighting, highway, main roads, parking lot, etc.

PRODUCT DESCRIPTION

Street luminaire for outdoor installation, aluminum body, Glass diffuser, stainless steel screws, Low power PHILIPS LED, IP66 rating.

FIXTURE CONSTRUCTION

Housing is made of corrosion-resistant die-cast aluminum, Polyester Powder-coated finishing, chemical wash treated. Stainless steel M8 bolts for mounting. Flat toughened glass to prevent upward light. Fixed to the frame with metal clips, silicon gasket, IP66 rated.

Dimension Drawing

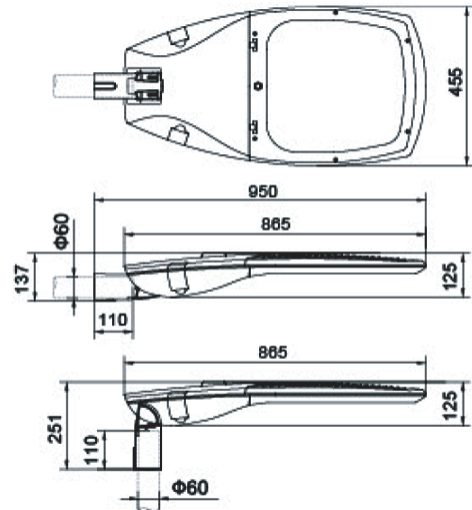

Photometric Data

Light Distribution Curve

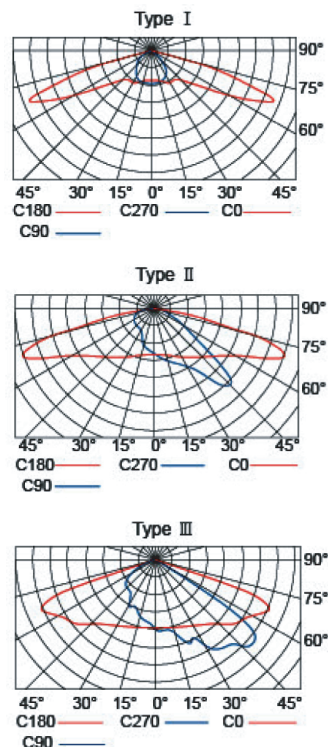

Illumination Drawing

