

# XL marlin Lighting

Prolux -Surface mounted ( XL129 ) Installation Instruction

The user: thank you for your purchase use this product, read this instruction manual before usage

1. Model: XL129
2. Rated Voltage: AC220-240V 50-60Hz
3. Rated Power: 6W/10W/16W
4. IP Grade: IP20
5. Operating Temperature: -20°C~40°C

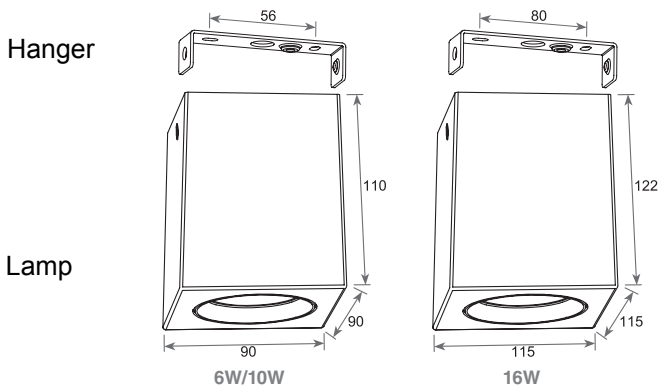

- Always disconnect the power supply before installing or performing any maintenance operations.
- Installation should be carried out by a suitably qualified person in accordance with good electrical practice and the appropriate national wiring regulations.
- These luminaires are widely used in commercial lighting, home decoration lighting, art gallery and museums.
- Only can be touched after 3 minutes later when power off, so as to avoid burns.
- Dismantling and refit are forbidden
- Installation on inflammables is forbidden.

If the external flexible cable or cord of this luminaire is damaged, it shall be exclusively replaced by the manufacturer or his service agent or a similar qualified person in order to avoid a hazard.

1. Select preferred colour temperature

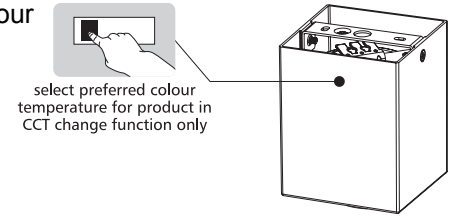

2. Loosen the screws on surface mounted frame.

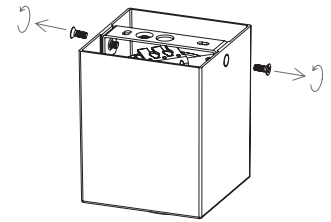

3. Fix the Hanger in the desired location

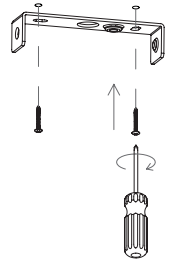

4. Connect the power supply

L — Switched  
 ⊕ — Earth  
 N — Neutral

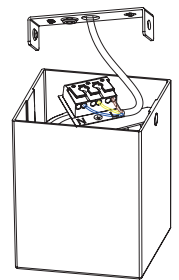

5. Screw back the lamp to the frame.

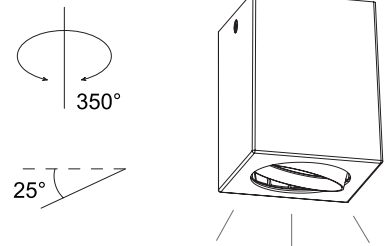

6. Connect the power supply, light up the lamp.

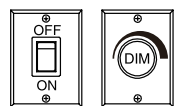

The light source of this luminaire is not replaceable; when the source reaches its end of life the whole luminaire shall be replaced

Welcome you again to buy our products