

XL marlin Lighting

Exterior Bollard Lighting (OLBLC12IN) installation Instruction

The user: Thank you for your purchase of this product, read this instruction manual before usage

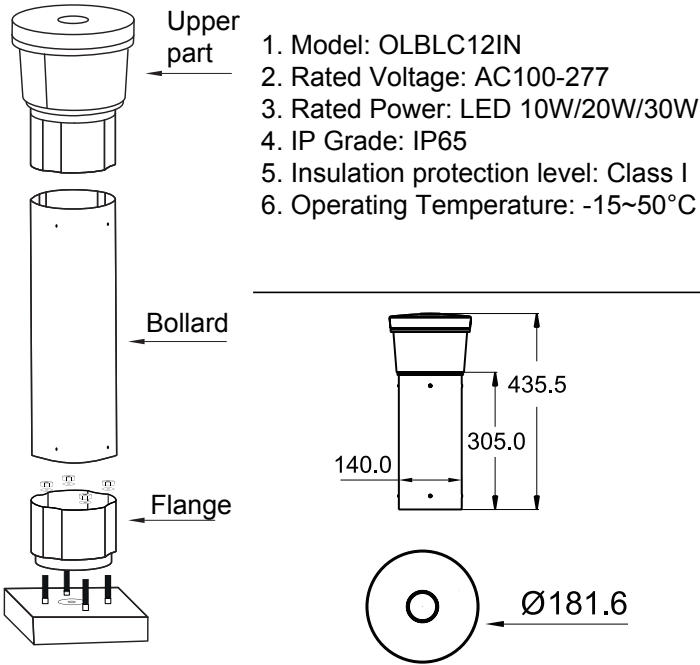

- Always disconnect the power supply before installing or performing any maintenance operations.
- Installation should be carried out by a suitably qualified person in accordance with good electrical practice and the appropriate national wiring regulations.
- These luminaires are widely used in commercial lighting, home decoration lighting, art gallery and museums.
- Only can be touched after 3 minutes later when power off, so as to avoid burns.
- Dismantling and refit are forbidden
- Installation on inflammables is forbidden.

If the external flexible cable or cord of this luminaire is damaged, it shall be exclusively replaced by the manufacturer or his service agent or a similar qualified person in order to avoid a hazard.

1. PREPARE THE GROUND FOR
 The depth of foundation pit shall be determined by digging to the original soil. In case of backfill, the recessed box can be embedded only after water injection and settlement.

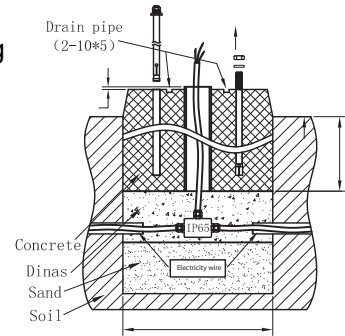

(A)

The lamp shall be mounted only when the concrete is completely solidified, and not before settling for 72H (3 days)

2. FIX THE FLANGE TO THE GROUND.
Be sure to fasten the flange tightly.
3. FIX THE BOLLARD TO THE FLANGE
Be sure to fasten the flange tightly.
4. CONNECT THE CABLE .
Live line for L terminal,
Null line for N terminal,
Ground line for E terminal.

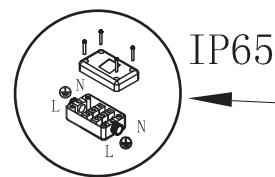
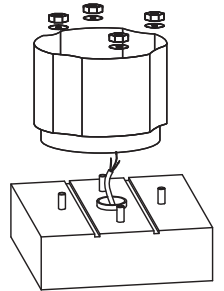

(A)

indicate same protection class IP 65 junction box .

5. CONNECT THE UPPER PART TO THE BOLLARD.
Be sure to fasten it tightly.
6. CONNECT THE POWER SUPPLY,
light up the lamp.

