

Model: XLHBL120WA



General Data

LED Power	107-116 W
System Power	118-129 W
Lamp Type	Philips Lumileds SMD3030
Luminous Flux	14,700-16,000 lm
CRI	>80
CCT	3000K or 4000K and 5700K
Beam angle	120°
Dimension	Ø330x200mm
Cut out dia.	/
Weight (kgs)	4.52 Kgs
Lamp Life	82,000 Hrs
Dimming	1-10 V / DALI
Oper. temp.	-20°-40°
SDCM	>3

Construction Data

IP rating	66 waterproof
Housing	Diecast Aluminum body
Heat sink	Die cast aluminum
Finish	Powder coated black colour
Loading capacity	/
Cable Gland	IP66
Gasket	Silicone rubber gasket

Electrical Data

Input voltage	AC 100~240V
Cable	Cable gland for waterproof IP65
Driver Type	Meanwell IP67

APPLICATIONS

Suitable for Warehouses, Workshops, Gymnasiums, Gas Stations, Toll Stations, Supermarkets, Exhibition halls and many other Industrial and commercial lighting applications.

PRODUCT DESCRIPTION

LED Highbay light, 5 years warranty, Philips Lumileds LED, Meanwell Driver, Diecast Aluminum body with Stainless steel screws 304/316, corrosion resistance. Multiple optical lens options. Multiple dimming options such as Dali and 1-10V Dimming.

Installation Methods

Multiple Installations such as mounting bracket with adjustable angle and Stainless steel screws 304/316, corrosion resistance. Also, available with Stainless steel hook 304 or optional Aluminium hook with clip.

Fixture Construction

Die cast Aluminum body in AkzoNobel powder coated black colour finish, Available in other colours, die cast aluminum heat sink.

Dimension Drawing

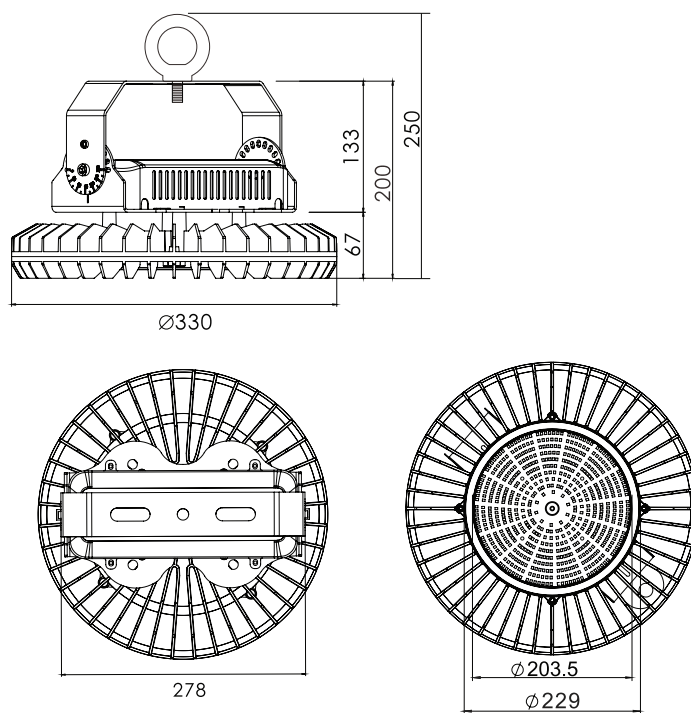

Lamp Options

Part Number	CCT	Beam angle
XLHBL120WAC3	3000 K	120°
XLHBL120WAC4	4000 K	120°
XLHBL120WAC57	5700 K	120°

Accessories



PC Cover

60° PC lens

70° Al Reflector

Model: XLHBL120WB



General Data

LED Power	103-115 W
System Power	114-127 W
Lamp Type	Philips Lumileds SMD3030
Luminous Flux	17,200-19,000 lm
CRI	>70
CCT	3000K or 4000K and 5700K
Beam angle	120°
Dimension	Ø330x200mm
Cut out dia.	/
Weight (kgs)	4.52 Kgs
Lamp Life	82,000 Hrs
Dimming	1-10 V / DALI
Oper. temp.	-20°-40°
SDCM	>3

Construction Data

IP rating	66 waterproof
Housing	Diecast Aluminum body
Heat sink	Die cast aluminum
Finish	Powder coated black colour
Loading capacity	/
Cable Gland	IP66
Gasket	Silicone rubber gasket

Electrical Data

Input voltage	AC 100~240V
Cable	Cable gland for waterproof IP65
Driver Type	Meanwell IP67

APPLICATIONS

Suitable for Warehouses, Workshops, Gymnasiums, Gas Stations, Toll Stations, Supermarkets, Exhibition halls and many other Industrial and commercial lighting applications.

PRODUCT DESCRIPTION

LED Highbay light, 5 years warranty, Philips Lumileds LED, Meanwell Driver, Diecast Aluminum body with Stainless steel screws 304/316, corrosion resistance. Multiple optical lens options. Multiple dimming options such as Dali and 1-10V Dimming.

Installation Methods

Multiple Installations such as mounting bracket with adjustable angle and Stainless steel screws 304/316, corrosion resistance. Also, available with Stainless steel hook 304 or optional Aluminium hook with clip.

Fixture Construction

Die cast Aluminum body in AkzoNobel powder coated black colour finish, Available in other colours, die cast aluminum heat sink.

Dimension Drawing

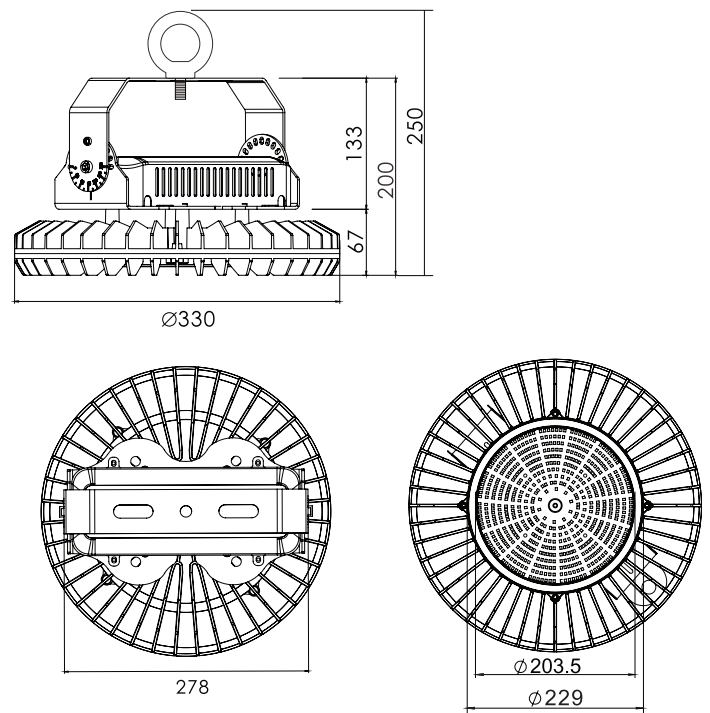

Lamp Options

Part Number	CCT	Beam angle
XLHBL120WBC3	3000 K	120°
XLHBL120WBC4	4000 K	120°
XLHBL120WBC57	5700 K	120°

Accessories



PC Cover

60° PC lens

70° Al Reflector