

Model: PR5F17IP20WH



General Data

Power	18W
LED type	LED SMD
Luminous flux	1875/2000 lm
CCT	3000K or 4000K as standard. Different CCT upon request.
CRI	83+
Beam angle	90°
Dimension	Ø147x64 mm
Cut out dia.	Ø125 mm
Weight (kgs)	1.65 Kgs
Lamp Life	50000 hrs
SDCM	≤5
Oper. Temp.	C -10° +45°
Certifications	CE, RoHS
Trim Color	White
Dimming	1-10V/DALI

Construction Data

IP rating	20 Indoor
Housing	Solid aluminum housing CNC machined body
Protection finishing	passivated (anodizing) anti-corrosion finishing
Glass	Tempered glass diffuser
Loading capacity	/
Cable Gland	IP20
Gasket	Silicone rubber gasket

Electrical Data

Input voltage	AC 230~240V
Cable	Cable gland

Accessories

Mounted Accessory	/
Clip	/

APPLICATIONS

Ideal for general lighting in retail, commercial and domestic applications. Particularly suitable where glare can be an issue because this light fixture has very low glare index

PRODUCT DESCRIPTION

Prolux down light is brilliant down light for general lighting, and wet areas made of die cast aluminum body, trim and heat sink, specular reflector to control the glare temperature, and high CRI 83 Ra. dimming is on request. IP20

FIXTURE CONSTRUCTION

Easy installation using screw arrangement for fixing from below, the reflector controls the glare and smooth the light beam angle, with forsted diffuser, the robust construction which is made from die cast aluminum and electronic remote driver.

Dimension Drawing

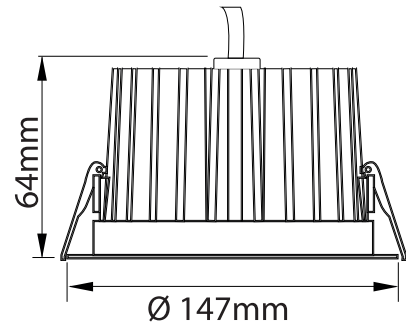

Lamp Options

Part Number	CCT	Beam angle
PR5F17IP20WH3	3000 K	90°
PR5F17IP20WH4	4000 K	90°

Photometric Data

Light Distribution Curve [Unit: cd]

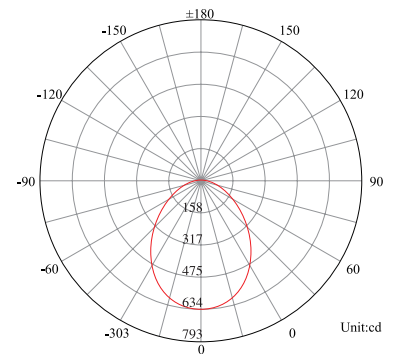

Lux distance Curve

