

XL marlin Lighting

Exterior Multiple Applications Lighting (OLLC00824W-V90) Installation Instruction

The user: Thank you for your purchase of this product, read this instruction manual before usage

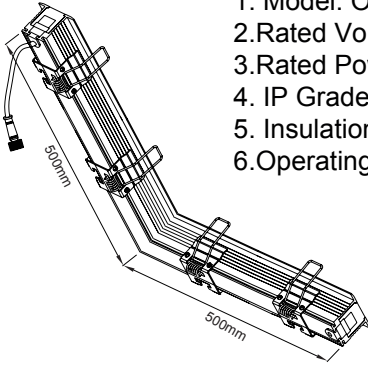

1. Model: OLLC00824W-V90
2. Rated Voltage: DC24V
3. Rated Power: LED 24 W
4. IP Grade: IP67
5. Insulation protection level: Class I
6. Operating Temperature: -15~50°C

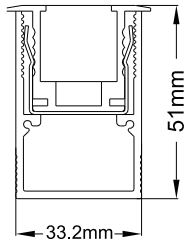
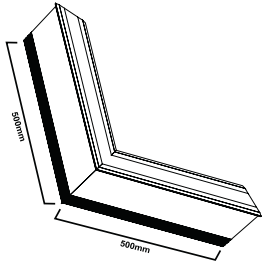

- Always disconnect the power supply before installing or performing any maintenance operations.
- Installation should be carried out by a suitably qualified person in accordance with good electrical practice and the appropriate national wiring regulations.
- These luminaires are widely used in commercial lighting, home decoration lighting, art gallery and museums.
- Only can be touched after 3 minutes later when power off, so as to avoid burns.
- Dismantling and refit are forbidden
- Installation on inflammables is forbidden.

If the external flexible cable or cord of this luminaire is damaged, it shall be exclusively replaced by the manufacturer or his service agent or a similar qualified person in order to avoid a hazard.

A- FIXTURE WITH SLEEVE INSTALLATION

1. PREPARE THE GROUND

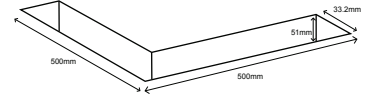

2. INSTALL INSTALLATION SLEEVE.

The sleeve must be fully supported from below and installed level.

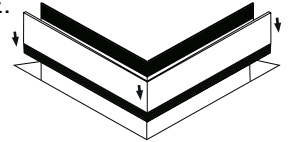

3. CONNECT CABLES.

Check the orientation of the fitting.
Make sure the connectors click together to ensure the IP seal.

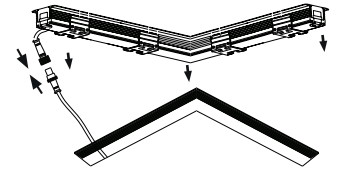

B- DIRECT FIXTURES INSTALLATION

1. PREPARE THE SURFACE.

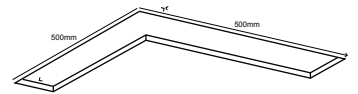

2. CONNECT CABLES.

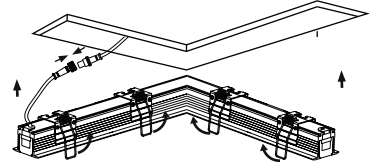

3. CAREFULLY INSERT THE FITTING light into the ceiling

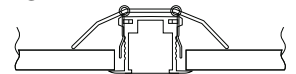

4. CONNECT THE POWER SUPPLY, light up the lamp.

TO CONNECT MORE THAN ONE FITTING

Remove the aluminium end cap from both fitting and connect Cables.

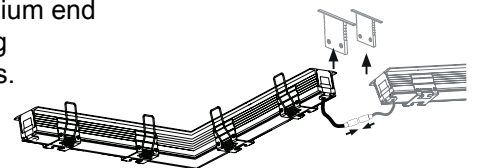

The light source of this luminaire is not replaceable; when the source reaches its end of life the whole luminaire shall be replaced

Welcome you again to buy our products