

Model: XLHBL200WA



General Data

LED Power	171-186 W
System Power	184-200 W
Lamp Type	Philips Lumileds SMD3030
Luminous Flux	23,200-25,300 lm
CRI	>80
CCT	3000K or 4000K and 5700K
Beam angle	120°
Dimension	Ø380x204mm
Cut out dia.	/
Weight (kgs)	5.68 Kgs
Lamp Life	82,000 Hrs
Dimming	1-10 V / DALI
Oper. temp.	-20°-40°
SDCM	>3

Construction Data

IP rating	66 waterproof
Housing	Diecast Aluminum body
Heat sink	Die cast aluminum
Finish	Powder coated black colour
Loading capacity	/
Cable Gland	IP66
Gasket	Silicone rubber gasket

Electrical Data

Input voltage	AC 100~240V
Cable	Cable gland for waterproof IP65
Driver Type	Meanwell IP67

APPLICATIONS

Suitable for Warehouses, Workshops, Gymnasiums, Gas Stations, Toll Stations, Supermarkets, Exhibition halls and many other Industrial and commercial lighting applications.

PRODUCT DESCRIPTION

LED Highbay light, 5 years warranty, Philips Lumileds LED, Meanwell Driver, Diecast Aluminum body with Stainless steel screws 304/316, corrosion resistance. Multiple optical lens options. Multiple dimming options such as Dali and 1-10V Dimming.

Installation Methods

Multiple Installations such as mounting bracket with adjustable angle and Stainless steel screws 304/316, corrosion resistance. Also, available with Stainless steel hook 304 or optional Aluminium hook with clip.

Fixture Construction

Die cast Aluminum body in AkzoNobel powder coated black colour finish, Available in other colours, die cast aluminum heat sink.

Dimension Drawing

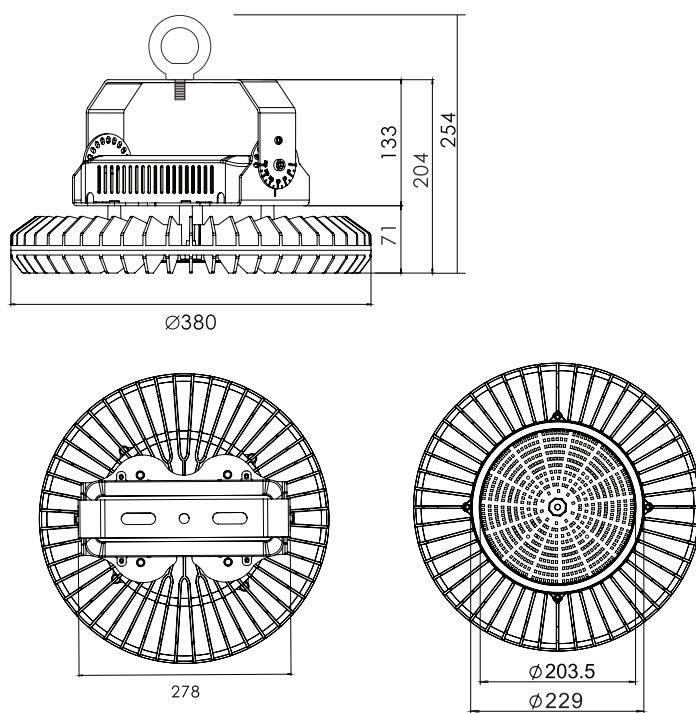

Lamp Options

Part Number	CCT	Beam angle
XLHBL200WAC3	3000 K	120°
XLHBL200WAC4	4000 K	120°
XLHBL200WAC57	5700 K	120°

Accessories



PC Cover

60° PC lens

70° Al Reflector

XL marlin Lighting

Hilux-Highbay Light Data Sheet

Model: XLHBL200WB



General Data

LED Power	193-210 W
System Power	206-230 W
Lamp Type	Philips Lumileds SMD3030
Luminous Flux	31,000-34,400 lm
CRI	>70
CCT	3000K or 4000K and 5700K
Beam angle	120°
Dimension	Ø380x204mm
Cut out dia.	/
Weight (kgs)	5.68 Kgs
Lamp Life	82,000 Hrs
Dimming	1-10 V / DALI
Oper. temp.	-20°-40°
SDCM	>3

Construction Data

IP rating	66 waterproof
Housing	Diecast Aluminum body
Heat sink	Die cast aluminum
Finish	Powder coated black colour
Loading capacity	/
Cable Gland	IP66
Gasket	Silicone rubber gasket

Electrical Data

Input voltage	AC 100~240V
Cable	Cable gland for waterproof IP65
Driver Type	Meanwell IP67

APPLICATIONS

Suitable for Warehouses, Workshops, Gymnasiums, Gas Stations, Toll Stations, Supermarkets, Exhibition halls and many other Industrial and commercial lighting applications.

PRODUCT DESCRIPTION

LED Highbay light, 5 years warranty, Philips Lumileds LED, Meanwell Driver, Diecast Aluminum body with Stainless steel screws 304/316, corrosion resistance. Multiple optical lens options. Multiple dimming options such as Dali and 1-10V Dimming.

Installation Methods

Multiple Installations such as mounting bracket with adjustable angle and Stainless steel screws 304/316, corrosion resistance. Also, available with Stainless steel hook 304 or optional Aluminium hook with clip.

Fixture Construction

Die cast Aluminum body in AkzoNobel powder coated black colour finish, Available in other colours, die cast aluminum heat sink.

Dimension Drawing

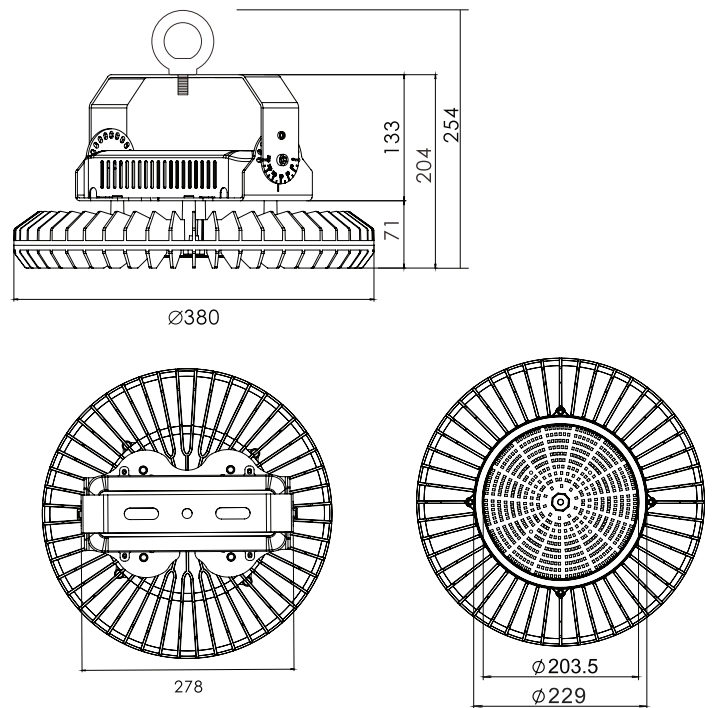

Lamp Options

Part Number	CCT	Beam angle
XLHBL200WBC3	3000 K	120°
XLHBL200WBC4	4000 K	120°
XLHBL200WBC57	5700 K	120°

Accessories



PC Cover

60° PC lens

70° Al Reflector