

Model: OLC003728



General Data

Power	6 W
LED type	CREE
Luminous flux	525 lm
CCT	3000K or 4000K as standard. Different CCT upon request.
CRI	80+
Beam angle	20°
Dimension	90x110x354mm
Cut out dia.	/
Weight (kgs)	2.35 kgs
Lamp Life	50000 hrs
SDCM	≤5
Ambient Temp.	-40°-45°
RAL Color	80+
Oper. Temp.	-30°-45°
Certifications	CE, RoHS

Construction Data

IP rating	IP65 Waterproof
Housing	Die-casting aluminum lamp body
Protection finishing	Graphene powder coating finish
Glass	Tempered glass diffuser
Loading capacity	2000 kgs
Cable Gland	PG7 IP67
Gasket	O-ring PMQ silicone seal
Rotatable	Manual rotation bracket max 20°+20°

Electrical Data

Input voltage	AC 110-240V
Cable	1PC rubber cable 1M
Driver	Low voltage constant current output, excluding the transformer

APPLICATIONS

These luminaires are designed using weatherproof and non-corrosive materials, widely used in exterior applications, such as lighting architectural features, landscape features, gardens, parks, footpaths, etc.

PRODUCT DESCRIPTION

Projector luminaire for outdoor installation, aluminum body, Glass diffuser, stainless steel screws, available with the flexibility of spike mounting for landscape installation. Low power CREE LED, IP65 rating.

FIXTURE CONSTRUCTION

Die-casting aluminum lamp body for better cooling performance, with Anodized aluminum reflector, Graphene power coating finish, Step Tempered Glass for high, silicone gasket and cable gland for waterproof IP65

Accessories

Mounting Sleeve /

Clip /

Dimension Drawing

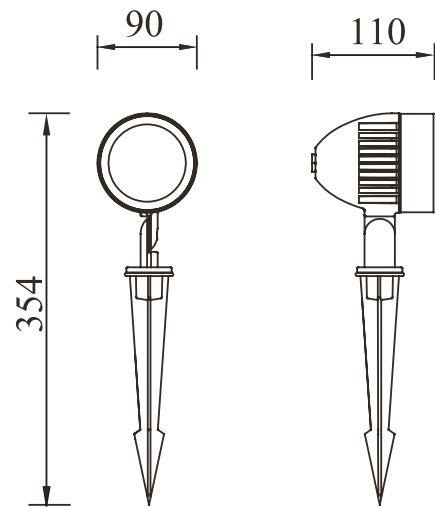

Lamp Options

Part Number	CCT	Beam angle
OLC003728C3	3000 K	20°
OLC003728C4	4000 K	20°

Photometric Data

Light Distribution Curve [Unit: cd]

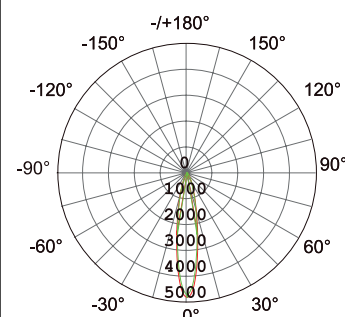

Illumination Drawing

