

XL marlin Lighting

Weatherproof Light (XLWP214FL) Installation Instruction

The user: thank you for your purchase use this product, read this instruction manual before usage

1. Model: XLWP214FL
2. Rated Voltage: 220-240V
3. Rated Power : 22W
4. IP Grade: IP65
5. Insulation protection level: Class I
6. Operating Temperature: -20° - +40°

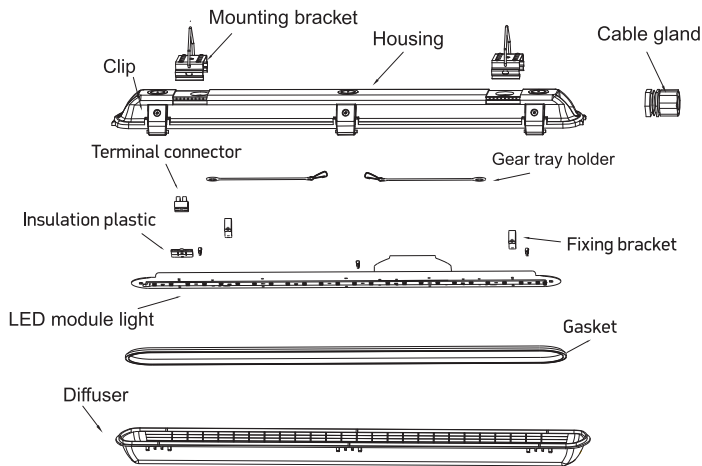
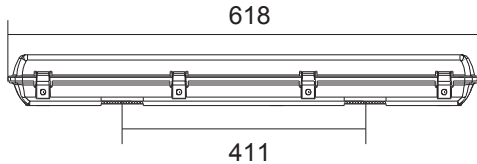
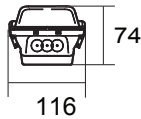

- Always disconnect the power supply before installing or performing any maintenance operations.
- Installation should be carried out by a suitably qualified person in accordance with good electrical practice and the appropriate national wiring regulations.
- These luminaires are widely used in commercial lighting, home decoration lighting, art gallery and museums.
- Only can be touched after 3 minutes later when power off, so as to avoid burns.
- Dismantling and refit are forbidden
- Installation on inflammables is forbidden.

If the external flexible cable or cord of this luminaire is damaged, it shall be exclusively replaced by the manufacturer or his service agent or a similar qualified person in order to avoid a hazard.

1. INSTALL MOUNTING BRACKET on the location, make sure the screws be fixed tightly.

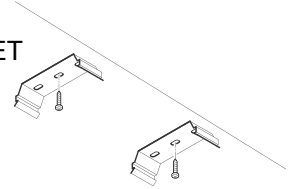

2. OPEN THE LAMP as shown in the drawing.

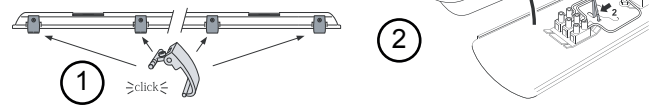

3. CONNECT THE CABLE .

- Live line for L terminal,
- Null line for N terminal,
- Ground line for E terminal.

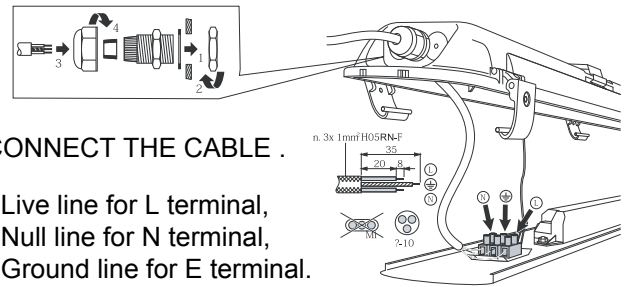

4. CLOSE THE LAMP as shown in the drawing.

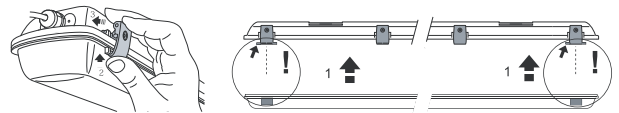

5. PUSH THE FIXTURE INTO THE MOUNTING BRACKET

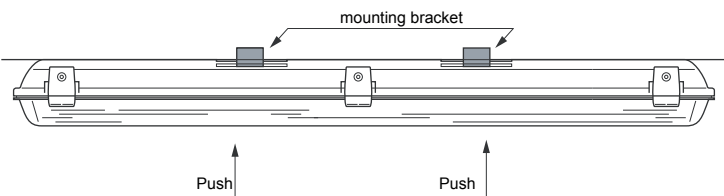

6. CONNECT THE POWER SUPPLY, light up the lamp.

The light source of this luminaire is not replaceable; when the source reaches its end of life the whole luminaire shall be replaced

Welcome you again to buy our products