

XL marlin Lighting

Exterior Wall Recessed Lighting (OLM023508B) Installation Instruction

The user: thank you for your purchase use this product, read this instruction manual before usage

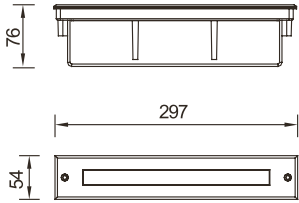

1. Model: OLM013508B
2. Rated Voltage: AC100-255V
3. Rated Power : 5W
4. IP Grade: IP65
5. Insulation protection level: Class I
6. Operating Temperature: -30°-45°

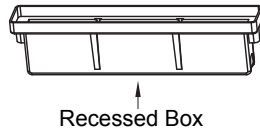
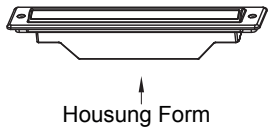

- Always disconnect the power supply before installing or performing any maintenance operations.
- Installation should be carried out by a suitably qualified person in accordance with good electrical practice and the appropriate national wiring regulations.
- These luminaires are widely used in commercial lighting, home decoration lighting, art gallery and museums.
- Only can be touched after 3 minutes later when power off, so as to avoid burns.
- Dismantling and refit are forbidden
- Installation on inflammables is forbidden.

If the external flexible cable or cord of this luminaire is damaged, it shall be exclusively replaced by the manufacturer or his service agent or a similar qualified person in order to avoid a hazard.

1. PREPARE THE WALL

Dug a hole according to the dimension of the mounting sleeve.

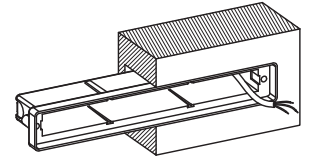

2. PLACE THE RECESSED BOX

3. CONNECT THE CABLE .

Live line for L terminal, Null line for N terminal, Ground line for E terminal.

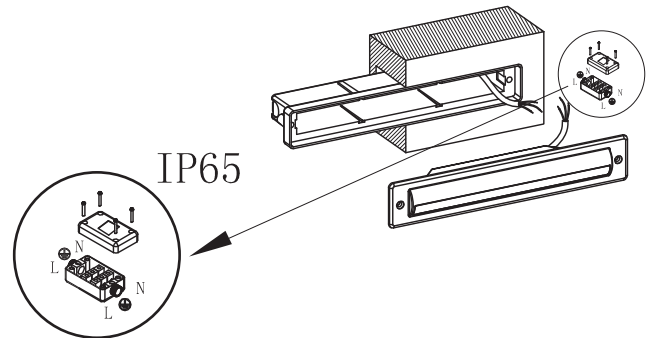

4. PUSH THE FIXTURE INTO THE RECESSED BOX.

Make sure the screws be fixed tightly.

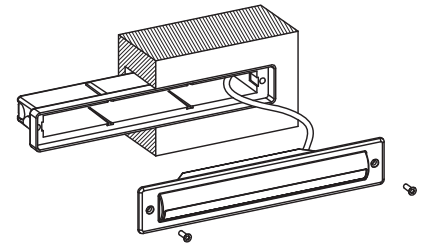

5. CONNECT THE POWER SUPPLY, light up the lamp.